

DSX-8000/DSX-5000

CableAnalyzer™

Getting Started Guide

The DSX CableAnalyzer modules attach to Versiv™ and Versiv 2 main and remote units to make rugged, hand-held testers that let you certify, troubleshoot, and document twisted pair network cabling.





DSX-8000 modules certify twisted pair cabling to Cat 8/Class I/II limits (2000 MHz) in less than 16 seconds.

DSX-5000 modules certify twisted pair cabling to Cat 7_A/Class F_A limits (1000 MHz) in less than 16 seconds.

Accessing the Product Manuals

This guide provides basic information to help you get started using the tester. For more detailed information, see the latest versions of the *Versiv Series Users Manual* and the *Versiv Series Technical Reference Handbook* provided on the Fluke Networks website. To download manuals, go to www.flukenetworks.com/support.

Symbols









	Warning or Caution: Risk of damage or destruction to equipment or software. See explanations in the manuals.
	Warning: Risk of fire, electric shock, or personal injury.
	Consult the user documentation.
	Conforms to the Appliance Efficiency Regulation (California Code of Regulations, Title 20, Sections 1601 through 1608), for small battery charging systems.



PN 4959174 January 2018, Rev. 1 12/2018

©2018 Fluke Corporation

All product names are trademarks of their respective companies.

	<p>Conformite Europeene. Conforms to the requirements of the European Union and the European Free Trade Association (EFTA).</p>
	<p>Certified by CSA Group to North American safety standards.</p>
	<p>Conforms to relevant Australian standards.</p>
	<p>Conforms to relevant Russian standards.</p>
	<p>EMC approval for Korea. Class A Equipment (Industrial Broadcasting and Communication Equipment). This product meets requirements for industrial (Class A) electromagnetic wave equipment and the seller or user should take notice of it. This equipment is intended for use in business environments and is not to be used in homes.</p>
	<p>This product complies with the WEEE Directive marking requirements. The affixed label indicates that you must not discard this electrical/electronic product in domestic household waste. Product Category: With reference to the equipment types in the WEEE Directive Annex I, this product is classed as category 9 "Monitoring and Control Instrumentation" product. Do not dispose of this product as unsorted municipal waste. To return unwanted products, contact the manufacturer's web site shown on the product or your local sales office or distributor.</p>
 LI-ion	<p>This Product contains a lithium-ion battery. Do not mix with the solid waste stream. Spent batteries should be disposed of by a qualified recycler or hazardous materials handler per local regulations. Contact your authorized Fluke Service Center for recycling information.</p>
	<p>40 year Environment Friendly Use Period (EFUP) under China Regulation - Administrative Measure on the Control of Pollution Caused by Electronic Information Products. This is the period of time before any of the identified hazardous substances are likely to leak out, causing possible harm to health and the environment.</p>
	<p>This key turns the Product on and off.</p>

Safety Information

Warning

To prevent possible fire, electric shock, or personal injury:

- Read all safety information before you use the Product.
- Carefully read all instructions.
- Do not connect the tester to telephony inputs, systems, or equipment, including ISDN inputs. Doing so is a misapplication of this product, which could result in damage to the tester and create a potential shock hazard to the user.
- Do not open the case. You cannot repair or replace parts in the case.
- Do not modify the Product.
- Use only replacement parts that are approved by Fluke Networks.
- Do not touch voltages > 30 V AC rms, 42 V AC peak, or 60 V DC.
- Do not use the Product around explosive gas, vapor, or in damp or wet environments.
- Use this Product indoors only.
- Do not connect the Product to voltages that are higher than the maximum voltage rating for the Product.
- For Products that have multiple connectors for different types of tests on copper cabling, disconnect unused test leads from the connectors before you do a test.
- Use the Product only as specified, or the protection supplied by the Product can be compromised.
- Do not use and disable the Product if it is damaged.
- Do not use the Product if it operates incorrectly.
- Batteries contain hazardous chemicals that can cause burns or explode. If exposure to chemicals occurs, clean with water and get medical aid.
- Remove the batteries if the Product is not used for an extended period of time, or if stored in temperatures above 50 °C. If the batteries are not removed, battery leakage can damage the Product.

- Replace the rechargeable battery after 5 years of moderate use or 2 years of heavy use. Moderate use is defined as recharged twice a week. Heavy use is defined as discharged to cutoff and recharged daily.
- Disconnect the battery charger and move the Product or battery to a cool, non-flammable location if the rechargeable battery becomes hot (>50 °C, >122 °F) during the charge period. The battery door must be closed and locked before you operate the Product.
- Repair the Product before use if the battery leaks.
- Recharge the batteries when the low battery indicator shows to prevent incorrect measurements.
- Turn off the Product and disconnect all test leads, patch cords, and cables before you replace the battery.
- Do not disassemble or crush battery cells and battery packs.
- Do not put battery cells and battery packs near heat or fire. Do not put in sunlight.
- Do not operate the Product with covers removed or the case open. Hazardous voltage exposure is possible.
- Remove the input signals before you clean the Product.
- Have an approved technician repair the Product.
- Do not put metal objects into connectors.
- For Products with rechargeable batteries, use only AC adapters approved by Fluke Networks for use with the Product to supply power to the Product and charge the battery.

Caution

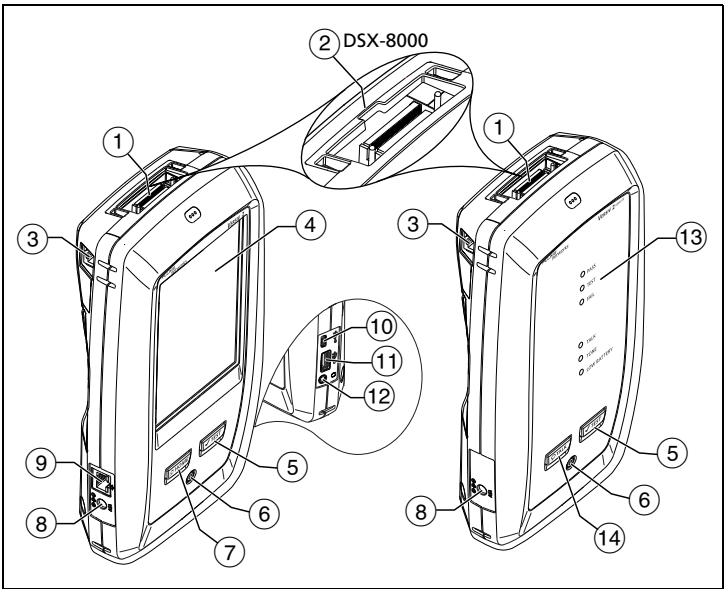

To prevent damage to the Product or cables under test and to prevent data loss, read all safety information given in all documentation supplied with the Product.

Connectors, Keys, and LEDs



HFO00.EPS

Figure 1. Connectors, Keys, and LEDs (Versiv 2 shown)

- ① Connector for a link interface adapter.
- ② DSX-8000 modules have a recess for the tabs on Cat 8/Class I/II adapters. You cannot attach Cat 8/Class I/II adapters to DSX-5000 modules.
- ③ RJ45 jack for communications between the main and remote testers when you do alien crosstalk measurements.
- ④ LCD display with touchscreen.
- ⑤  **TEST**: Starts a test. To start a test, you can also tap **TEST** on the display.
- ⑥ Power button.
Versiv 2: The LED in the power button shows the status of the battery charging process. See the Users Manual.
- ⑦  **HOME**: Press  **HOME** to go to the home screen.
- ⑧ Connector for the AC adapter.
Versiv: The LED is red when the battery charges, and green when the battery is fully charged. The LED is yellow if the battery will not charge.
- ⑨ RJ45 connector: Lets you connect to a network for access to Fluke Networks cloud services.

- ⑩ Micro USB port: This USB port lets you connect the tester to a PC so you can upload test results to the PC and install software updates in the tester.
- ⑪ Type A USB port: This USB host port lets you save test results on a USB flash drive and connect the FI-1000 video probe to the tester.

Versiv: You can also connect a Wi-Fi adapter for access to Fluke Networks cloud services. (Versiv 2 testers have an internal Wi-Fi radio.)

- ⑫ Headset jack.
- ⑬ **PASS** LED comes on when a test passes.

TEST LED comes on during a test.

FAIL LED comes on when a test fails.



TALK LED comes on when the talk function is on (see ⑭). To adjust the volume, press  or the button on the headset's microphone.

tone LED flashes and the toner comes on when you press  and a main tester is not connected to the remote.

LOW BATTERY LED comes on when the battery is low.

Note

The LEDs also operate as a battery gauge when you turn on the remote. See the Users Manual.

- ⑭ : Press  to use the headset to speak to the person at the other end of the link. Press again to adjust the volume. To turn off the talk function, hold down .

How to Certify Twisted Pair Cabling

1 Power the Tester

Charge the battery if necessary. Connect the AC adapter to AC power and to the adapter connector (⑧) shown in Figure 1. You can use the tester while the battery charges.

-continued-

2 Select Settings

- 2-1 On the home screen, tap the test setup panel (see Figure 2, number ②).
- 2-2 On the **CHANGE TEST** screen, tap a twisted pair test, then tap **EDIT**.
- 2-3 On the **TEST SETUP** screen, tap the panels to change settings.
- 2-4 To save the settings, tap **SAVE** on the **TEST SETUP** screen.

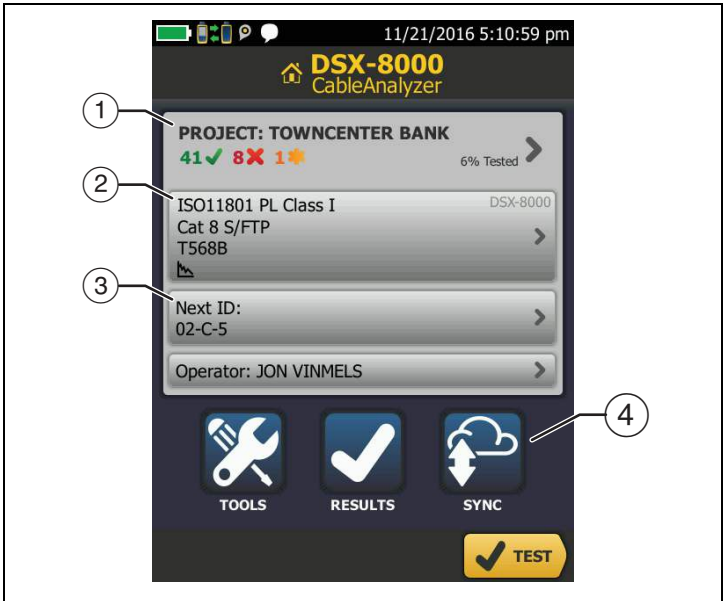

HFO01.EPS

Figure 2. Panels on the Home Screen

- ① To set up a project, tap the **PROJECT** panel.
- ② To change settings for the test or select a different test, tap the test setup panel.
- ③ To set up cable IDs and turn on **Auto Save**, tap the **Next ID** panel.
- ④ To upload test results to LinkWare Live, tap **SYNC**.

3 Set the Reference

- 3-1 Turn on the tester and the remote a minimum of 5 minutes before you set the reference.

Note

Set the reference only after the testers are at an ambient temperature between 50 °F and 104 °F (10 °C and 40 °C).

- 3-2 On the home screen, tap **TOOLS**, then tap **Set Reference**.
- 3-3 Make the connections to set the reference as shown on the screen, then tap **TEST**.

4 Make Connections and Do a Test

- 4-1 Connect the testers to the link as shown in Figure 3 or 4.
- 4-2 Tap **TEST** on the main tester or press **TEST** on the main or remote tester.

Note

Cat 8/Class III permanent links can have two connectors and a maximum length of 24 m. See the Users Manual for connection diagrams.

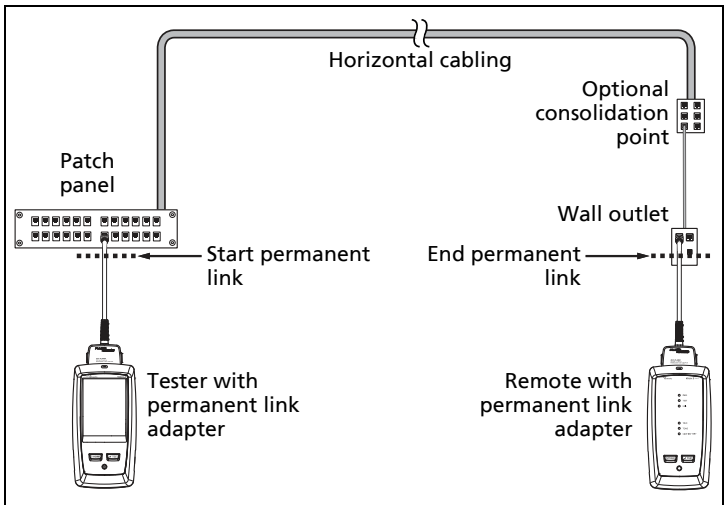
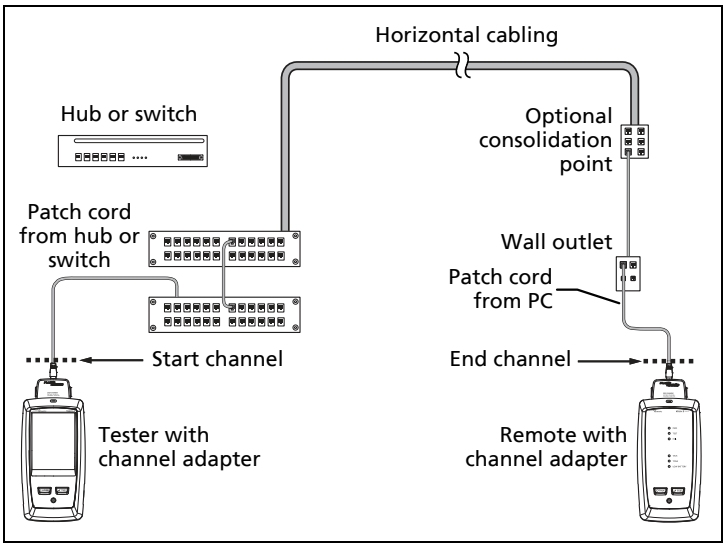

Figure 3. Permanent Link Connections for Links Up to Cat 7_A



GPU96.EPS

Figure 4. Channel Connections for Links Up to Cat 7_A

5 Examine the Results

The tester shows multiple views of the test results (Figure 5):

- **WIRE MAP:** Shows the connections between the ends of the cable under test. The tester compares the connections to the selected Outlet Configuration to get a **PASS** or **FAIL** result.
- **PERFORMANCE:** Shows the overall result for each test that is required by the selected test limit. To see detailed results for a test, tap the panel.

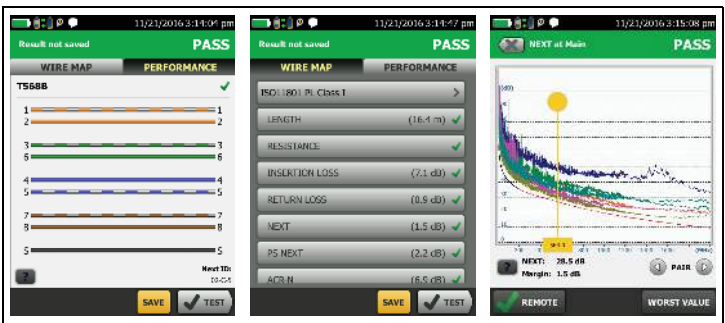

HFO02.EPS

Figure 5. Examples of Twisted Pair Results Screens

6 Save the Results

6-1 Tap **SAVE** if the test passed or **FIX LATER** if the test failed.

6-2 If the **Cable ID** box shows the correct ID, tap **SAVE**.

To enter a cable ID, tap the **Cable ID** box on the **SAVE RESULT** screen, use the keyboard to enter a name for the results, tap **DONE**, then tap **SAVE**.

The tester saves the results in the **DEFAULT** project, unless you selected a different project.

About Projects

You can set up a project to specify the settings and tests necessary for a job, monitor the status of a job, and organize the test results.

To start a new project, tap **PROJECT** on the home screen, tap **CHANGE PROJECT**, then tap **NEW PROJECT**. See the Users Manual or Technical Reference Handbook for more information.

About Fluke Networks Cloud Services

With a Fluke Networks web account and a wired or wireless network connection, you can use the LinkWare™ Live web application to store and manage projects in the cloud.

Go to www.linkwarelive.com/signin or see the Users Manual or Technical Reference Handbook for more information.

About the AxTalk Analyzer Kit

The DSX-8000 CableAnalyzer kit includes the hardware you need to do tests for alien crosstalk on twisted pair cabling. Alien crosstalk is noise, or crosstalk, transmitted between adjacent cables in a bundle or patch panel. Alien crosstalk is a primary source of noise in cabling used for 10GBASE-T applications and above.

For instructions on how to do alien crosstalk tests, install the AxTalk Analyzer software, which is available on the Fluke Networks website, then see the online help in the software.

Registration

Registering your product with Fluke Networks gives you access to valuable information on product updates, troubleshooting tips, and other support services.

To register, use LinkWare PC software. Download LinkWare PC from the Fluke Networks website.

Contact Fluke Networks



www.flukenetworks.com/support



info@flukenetworks.com



1-800-283-5853, +1-425-446-5500



Fluke Networks

6920 Seaway Boulevard, MS 143F

Everett WA 98203 USA

Fluke Networks operates in more than 50 countries worldwide. For more contact information, go to our website.

General Specifications

Battery Type	Lithium-ion
Power Adapter	Input: 100 to 240 VAC \pm 10%, 50/60Hz Output: 15 VDC, 2 A maximum Class II
Versiv 2 wireless radio*	Frequency ranges: 2.4 GHz band: 2412 MHz to 2484 MHz 5 GHz band: 4910 MHz to 5825 MHz Output power: <100 mW
Temperature	Operating: 0 °C to +45 °C Charging: 0 °C to +45 °C Storage: -10 °C to +60 °C
Altitude	Operating: 4,000 m (3,200 m with AC adapter) Storage: 12,000 m
* For more information, go to www.flukenetworks.com/manuals and search for "Radio Frequency Data for Class A".	

LIMITED WARRANTY AND LIMITATION OF LIABILITY

Fluke Networks mainframe products will be free from defects in material and workmanship for one year from the date of purchase, unless stated otherwise herein. Parts, accessories, product repairs and services are warranted for 90 days, unless otherwise stated. Ni-Cad, Ni-MH and Li-Ion batteries, cables or other peripherals are all considered parts or accessories. This warranty does not cover damage from accident, neglect, misuse, alteration, contamination, or abnormal conditions of operation or handling. Resellers are not authorized to extend any other warranty on Fluke Networks' behalf. To obtain service during the warranty period, contact your nearest Fluke Networks authorized service center to obtain return authorization information, then send your defective product to that Service Center with a description of the problem.

For a list of authorized resellers, visit www.flukenetworks.com/wheretobuy.

THIS WARRANTY IS YOUR ONLY REMEDY. NO OTHER WARRANTIES, SUCH AS FITNESS FOR A PARTICULAR PURPOSE, ARE EXPRESSED OR IMPLIED. FLUKE NETWORKS IS NOT LIABLE FOR ANY SPECIAL, INDIRECT, INCIDENTAL OR CONSEQUENTIAL DAMAGES OR LOSSES, ARISING FROM ANY CAUSE OR THEORY. Since some states or countries do not allow the exclusion or limitation of an implied warranty or of incidental or consequential damages, this limitation of liability may not apply to you.

4/15

Fluke Networks
PO Box 777
Everett, WA 98206-0777
USA